



rk steel smith
defining workspace

PERFO. PANEL, HOOK & TROLLEY
PLASTIC BINS
LOUVER PANEL, HOOK & RACK

PRODUCT RANGE



2018



Perfo. Panel — 03



Perfo. Panel Hook — 04 to 07



Perfo. Panel Trolley — 08 & 09



Plastic Bins — 10 & 11



Louver Panel & Hook — 12 & 13



Louver Wall Panel — 14 & 15



Louver Panel Rack — 16 to 19



Colour — 20

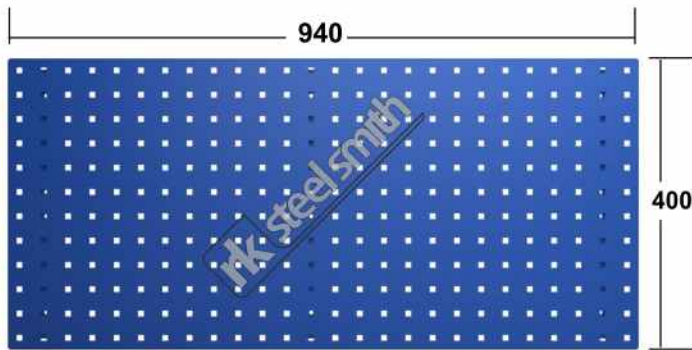

RK PERFO PT-01

The Louvre Panels are made from 1.6 mm Galvanised steel duly powder coated finish

Minimum order Qty. - 05no.

Standard Hook Detail on [Page- 04 To 07](#)

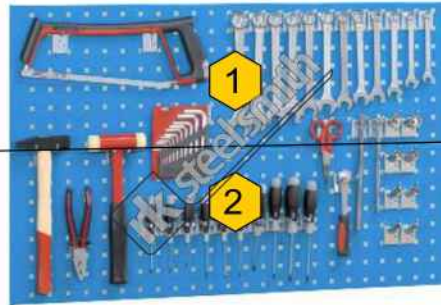

Example: 2 panel Horizontal



Example: 4 panel Horizontal

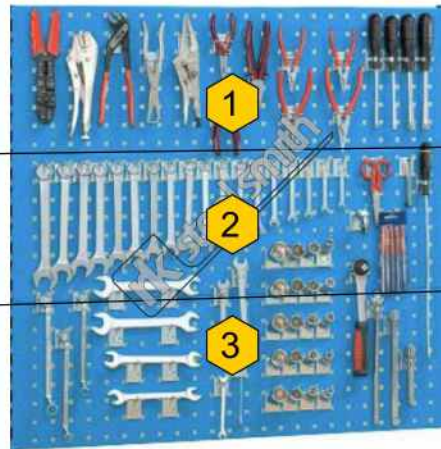

Example: 3 panel Horizontal

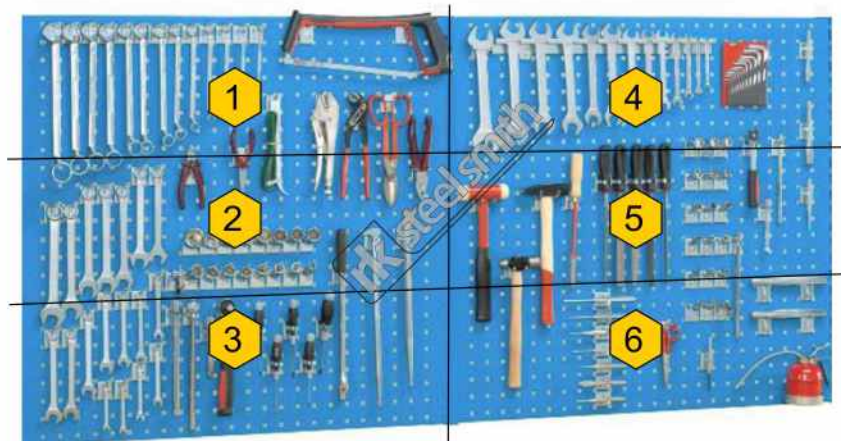

Example: 6 panel Horizontal

H-01



Single hook:

Use for Pliers, Hacksaw frame, Scale, Saw blade/cutter, Scissor, Eye bolts, Ring spanner, Adjustable spanner, Measuer tap, Torque wrench, Right angle, Etc.

H-04



Double hook:

Use for Hammer 'C' clamp, T spanner, Etc

H-02

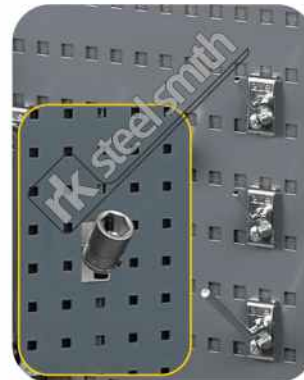

Box spanner OR Socket hook:

Use for 1no. box spanner

H-05

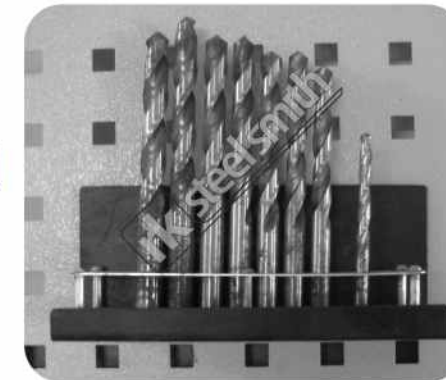

Drill bit stand hook:

Use for 1mm to 13mm

H-03



Pipe hook:

28.5mm X 100mm long dia. Use for screw driver, small round files, drills, plier. Etc.

H-06



File hook:

Use for file - 5no. OR Scrapper - 5no. OR screw driver - 5no.

H-07



Oil can hook:

Use for machine oil can

H-10



Fix spanner hook:

Use for 6/7, 10/11, 12/13, 14/15, 16/17, 18/19, 20/22 mm

H-08



Plastic single bin hook (with bin)

SB-2: 100 W. X 175 D. X 85 H.-1no.

H-11



5no. Magnet

H-09



Plastic multi bin hook (with bin)

SB-1: 95 W. X 120 D. X 60 H. (4no.)

OR

SB-2: 100 W. X 175 D. X 85 H.-4no.

OR

SB-3: 130 W. X 220 D. X 125 H. (3no.)

H-12



Square bottle hook:

Use for misc.
100mm Square X 80mm height

H-15



Allen key hook:

Use for 2 to 12mm

H-13



Shelve hook:

Use for misc.
400mm W. X 150mm D. X 25mm H.

H-16



Prong hook:

Use for misc.

H-14



Saw blade OR Frame hook:

Use for 3no. saw frame

H-17



J hook:

Use for Long tool, Torque wrench,
Long gauge, misc.



H-18



Hand graindig machine hook:

Use for 100mm (4") disc

H-20



Right angle hook:

100mm/150mm/200mm

H-19



U holder hook:

Use for misc.
50mm Wide X100mm Length

H-21



Hand drill machine hook:

Use for 10mm drill



Technical Detail:

- (1) **Overall Dimension:** 1025mm W. X 650mm D. X 1650mm H.
- (2) **PU wheel:** 125mm dia. X 32 thk. (2-fix, 2-brake)
- (3) **Perfo Panel Area:** 1000 W.X 1200H. **(front & back)**
- (4) **Load capacity:** 300 Kg.

RK PERFO PT-09



Standard Hook Detail on [Page- 04 To 07](#)



Technical Detail:

- (1) **Overall Dimension:** 1025mm W. X 650mm D. X 1650mm H.
- (2) **PU wheel:** 125mm dia. X 32 thk. (2-fix, 2-brake)
- (3) **Perfo Panel Area:** 1000 W.X 800H. **(front & back)**
- (4) **Plastic Bull Bin -15:** 125W. X 201D. X 101H. - **48no. (24 front & 24 back)**
- (5) **Load capacity:** 300 Kg.

Plastic Bin included

RK PERFO PT-10

Bin Mounting Rail





Technical Detail:

- (1) **Overall Dimension:** 1025mm W. X 650mm D. X 1650mm H.
- (2) **PU wheel:** 125mm dia. X 32 thk. (2-fix, 2-brake)
- (3) **Perfo Panel Area:** 1000 W.X 800H. (front & back)
- (4) **Plastic Bull Bin -15:** 125W. X 201D. X 101H. - **12no. (6 front & 6 back)**
- (5) **Plastic Bull Bin -35:** 208W. X 300D. X 158H. - **16no. (8 front & 8 back)**
- (6) **Load capacity:** 300 Kg.

Plastic Bin included

RK PERFO PT-11



Bin Mounting Rail



Standard Hook Detail on [Page- 04 To 07](#)



Bin Mounting Rail



Technical Detail:

- (1) **Overall Dimension:** 1025mm W. X 650mm D. X 1650mm H.
- (2) **PU wheel:** 125mm dia. X 32 thk. (2-fix, 2-brake)
- (3) **Perfo Panel Area:** 1000 W.X 800H. (front & back)
- (4) **Plastic Bull Bin -35:** 208W. X 300D. X 158H. - **24no. (12 front & 12 back)**
- (5) **Load capacity:** 300 Kg.

Plastic Bin included

RK PERFO PT-12



MADE FROM POLYPROPYLENE COPOLYMER.

Provision for vertical partitions to increase storage options in RK BU BIN 725, RK BU BIN 835 & RK BU BIN 945.

Full length rear lip supports provided for hanging bins on louvered panels or rails. (Except for RK BIN 1055)

Resistant to most industrial solvents.

Anti skid strips provided at the base.

Bins are designed to stack one on top of each other.

Extra wide stacking base for secure stacking.

Tapered front & rear bottom for easy movement on conveyers.

Stopper prevents stacked bins from shifting forward.

Extra wide label slot for easy content identification.

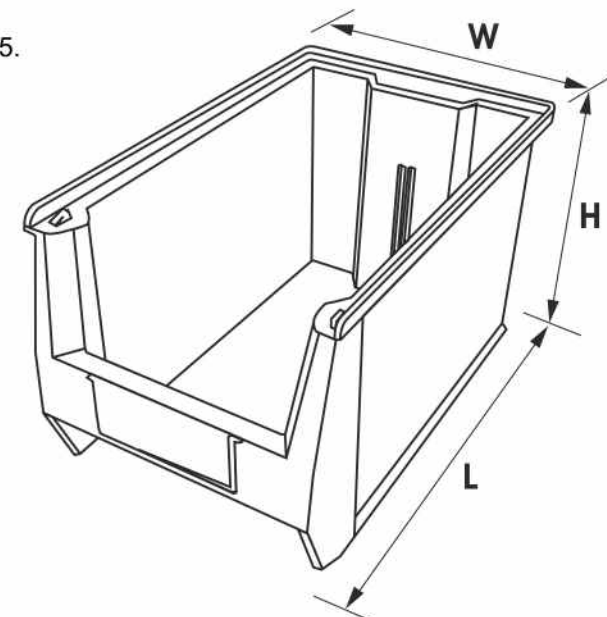



RK BU BIN 005

Outside Dimensions in mm : 168 (L) x 102 (W) x 74 (H)
 Inside Dimensions in mm : 145 (L) x 86 (W) x 66 (H)
 Effective Height in mm : 38
 Standard Packing : 60 pcs. per ctn.
 Slots for Partition : NA
 Colour : Red / Blue



RK BU BIN 835

Outside Dimensions in mm : 300 (L) x 208 (W) x 158 (H)
 Inside Dimensions in mm : 255 (L) x 185 (W) x 145 (H)
 Effective Height in mm : 80
 Standard Packing : 20 pcs. per ctn.
 Slots for Partition : NA
 Colour : Red / Blue



RK BU BIN 615

Outside Dimensions in mm : 201 (L) x 125 (W) x 101 (H)
 Inside Dimensions in mm : 178 (L) x 105 (W) x 92 (H)
 Effective Height in mm : 48
 Standard Packing : 40 pcs. per ctn.
 Slots for Partition : NA
 Colour : Red / Blue



RK BU BIN 945

Outside Dimensions in mm : 348 (L) x 210 (W) x 200 (H)
 Inside Dimensions in mm : 305 (L) x 187 (W) x 185 (H)
 Effective Height in mm : 110
 Standard Packing : 10 pcs. per ctn.
 Slots for Partition : NA
 Colour : Red / Blue



RK BU BIN 725

Outside Dimensions in mm : 229 (L) x 150 (W) x 126 (H)
 Inside Dimensions in mm : 192 (L) x 128 (W) x 114 (H)
 Effective Height in mm : 58
 Standard Packing : 50 pcs. per ctn.
 Slots for Partition : NA
 Colour : Red / Blue



RK BU BIN 1055

Outside Dimensions in mm : 510 (L) x 310 (W) x 200 (H)
 Inside Dimensions in mm : 480 (L) x 280 (W) x 195 (H)
 Effective Height in mm : 85
 Standard Packing : 8 pcs. per ctn.
 Slots for Partition : NA
 Colour : Red / Blue

The Louvre Panels are made from 1.6 mm CRCA steel duly powder coated finish and are available in four sizes.

RK LP 1830-01

460 W. x 1830 H.



RK LP 915-01

460 W. x 915 H.



RK LP 610-01

460 W. x 610 H.



RK LP 460-01

460 W. x 460 H.



Louvre Panel Hooks are available in 8 different sizes. These hooks are ideal for hanging a variety of parts such as fan belts, gaskets, hoses, automotive parts and packaged items.

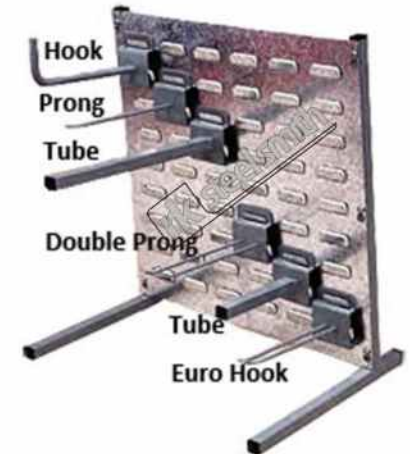

LPH1



LPH5



LPH2



LPH6

LPH3



LPH7



LPH4



LPH8

Discription

LPH1----- Single Prong 200mm (L) x 6mm (D) Rod

LPH2----- Double Prong 200mm (L) x 6mm (D) Rod

LPH3----- Pipe Hook 150mm (L) (20mm x 20mm x 1.5mm pipe section)

LPH4----- Pipe Hook 250mm (L) (20mm x 20mm x 1.5mm pipe section)

LPH5----- Pipe Hook 300mm (L) (20mm x 20mm x 1.5mm pipe section)

LPH6----- Steel Hook 200mm (L) x 9.5mm (D) Rod

LPH7----- Euro Hook 200mm (L) x 6mm (D) Rod

LPH8----- Chrome Wire Hook 150mm (L) x 5mm (D)



WALL FITTING LOUVRE PANELS

Are manufactured from 1.5mm CRCA steel and powder coated in RK BINS can be mounted with ease in variable combinations as listed below :



460 W. x 460 H.



RK BU PANEL 460-01

460mm W. x 460mm H.-----**RK BU BIN 005**-----24no.-----Bin Size 168 (L) x 102 (W) x 74 (H)

RK BU PANEL 460-02

460mm W. x 460mm H.-----**RK BU BIN 615**-----12no.-----Bin Size 201 (L) x 125 (W) x 101 (H)

RK BU PANEL 460-03

460mm W. x 460mm H.-----**RK BU BIN 725**-----09no.-----Bin Size 229 (L) x 150 (W) x 126 (H)

460 W. x 610 H.



RK BU PANEL 610-01

460mm W. x 610mm H.-----**RK BU BIN 005**-----36no.-----Bin Size 168 (L) x 102 (W) x 74 (H)

RK BU PANEL 610-02

460mm W. x 610mm H.-----**RK BU BIN 615**-----15no.-----Bin Size 201 (L) x 125 (W) x 101 (H)

RK BU PANEL 610-03

460mm W. x 610mm H.-----**RK BU BIN 725**-----12no.-----Bin Size 229 (L) x 150 (W) x 126 (H)

RK BU PANEL 610-04

460mm W. x 610mm H.-----**RK BU BIN 835**-----06no.-----Bin Size 300 (L) x 208 (W) x 158 (H)

RK BU PANEL 610-05

460mm W. x 610mm H.-----**RK BU BIN 945**-----06no.-----Bin Size 300 (L) x 215 (W) x 140 (H)

460 W. x 915 H.



RK BU PANEL 915-01

460mm W. x 915mm H.-----**RK BU BIN 005**-----48no.-----Bin Size 168 (L) x 102 (W) x 74 (H)

RK BU PANEL 915-02

460mm W. x 915mm H.-----**RK BU BIN 615**-----24no.-----Bin Size 201 (L) x 125 (W) x 101 (H)

RK BU PANEL 915-03

460mm W. x 915mm H.-----**RK BU BIN 725**-----18no.-----Bin Size 229 (L) x 150 (W) x 126 (H)

RK BU PANEL 915-04

460mm W. x 915mm H.-----**RK BU BIN 835**-----10no.-----Bin Size 300 (L) x 208 (W) x 158 (H)

RK BU PANEL 915-05

460mm W. x 915mm H.-----**RK BU BIN 945**-----08no.-----Bin Size 348 (L) x 210 (W) x 200 (H)

460 W. x 1830 H.



RK BU PANEL 1830-01

460mm W. x 1830mm H.-----**RK BU BIN 005**-----96no.-----Bin Size 168 (L) x 102 (W) x 74 (H)

RK BU PANEL 1830-02

460mm W. x 1830mm H.-----**RK BU BIN 615**-----48no.-----Bin Size 201 (L) x 125 (W) x 101 (H)

RK BUN PANEL 1830-03

460mm W. x 1830mm H.-----**RK BU BIN 725**-----36no.-----Bin Size 229 (L) x 150 (W) x 126 (H)

RK BU PANEL 1830-04

460mm W. x 1830mm H.-----**RK BU BIN 835**-----20no.-----Bin Size 300 (L) x 208 (W) x 158 (H)

RK BU PANEL 1830-05

460mm W. x 1830mm H.-----**RK BU BIN 945**-----16no.-----Bin Size 348 (L) x 210 (W) x 200 (H)

RK BU PANEL 1830-06

460mm W. x 1830mm H.-----**RK BU BIN 005**-----24no.-----Bin Size 168 (L) x 102 (W) x 74 (H)

460mm W. x 1830mm H.-----**RK BU BIN 615**-----12no.-----Bin Size 201 (L) x 125 (W) x 101 (H)

460mm W. x 1830mm H.-----**RK BU BIN 725**-----09no.-----Bin Size 229 (L) x 150 (W) x 126 (H)

460mm W. x 1830mm H.-----**RK BU BIN 835**-----04no.-----Bin Size 300 (L) x 208 (W) x 158 (H)



Free standing stands are made from M.S. Steel Square Pipes of size 30mm (L) x 30mm (W) x 2.0mm (T) and are duly powder coated in These stands are used to mount louvre panels 460mm W. x 915mm H. (1no.)
Louvres can be mounted on single side use.



Dimension : 475mm (W) X 630mm (D) X 1560mm (H)

RK BU STAND 915-1560-01-S

RK BU BIN 005-----48no.-----Bin Size 168 (L) x 102 (W) x 74 (H)-----Single Side

RK BU STAND 915-1560-02-S

RK BU BIN 615-----24no.-----Bin Size 201 (L) x 125 (W) x 101 (H)-----Single Side

RK BU STAND 915-1560-03-S

RK BU BIN 725-----18no.-----Bin Size 229 (L) x 150 (W) x 126 (H)-----Single Side

RK BU STAND 915-1560-04-S

RK BU BIN 835-----10no.-----Bin Size 300 (L) x 208 (W) x 158 (H)-----Single Side

RK BU STAND 915-1560-05-S

RK BU BIN 945-----08no.-----Bin Size 348 (L) x 210 (W) x 200 (H)-----Single Side

RK BU STAND 915-1560-06-S

RK BU BIN 005-----24no.-----Bin Size 168 (L) x 102 (W) x 74 (H)-----Single Side

RK BU BIN 615-----12no.-----Bin Size 201 (L) x 125 (W) x 101 (H)-----Single Side

RK BU STAND 915-1560-07-S

RK BU BIN 725-----09no.-----Bin Size 229 (L) x 150 (W) x 126 (H)-----Single Side

RK BU BIN 835-----04no.-----Bin Size 300 (L) x 208 (W) x 158 (H)-----Single Side

Free standing stands are made from M.S. Steel Square Pipes of size 30mm (L) x 30mm (W) x 2.0mm (T) and are duly powder coated in These stands are used to mount louvre panels 460mm W. x 915mm H. (2no.)
Louvres can be mounted on double side use.



Dimension : 475mm (W) X 630mm (D) X 1560mm (H)

RK BU STAND 915-1560-01-D

RK BU BIN 005-----96no.-----Bin Size 168 (L) x 102 (W) x 74 (H)-----Double Side

RK BU STAND 915-1560-02-D

RK BU BIN 615-----48no.-----Bin Size 201 (L) x 125 (W) x 101 (H)-----Double Side

RK BU STAND 915-1560-03-D

RK BU BIN 725-----36no.-----Bin Size 229 (L) x 150 (W) x 126 (H)-----Double Side

RK BU STAND 915-1560-04-D

RK BU BIN 835-----20no.-----Bin Size 300 (L) x 208 (W) x 158 (H)-----Double Side

RK BU STAND 915-1560-05-D

RK BU BIN 945-----16no.-----Bin Size 348 (L) x 210 (W) x 200 (H)-----Double Side

RK BU STAND 915-1560-06-D

RK BU BIN 005-----48no.-----Bin Size 168 (L) x 102 (W) x 74 (H)-----Double Side

RK BU BIN 615-----24no.-----Bin Size 201 (L) x 125 (W) x 101 (H)-----Double Side

RK BU STAND 915-1560-07-D

RK BU BIN 725-----18no.-----Bin Size 229 (L) x 150 (W) x 126 (H)-----Double Side

RK BU BIN 835-----08no.-----Bin Size 300 (L) x 208 (W) x 158 (H)-----Double Side

Free standing stands are made from M.S. Steel Square Pipes of size 30mm (L) x 30mm (W) x 2.0mm (T) and are duly powder coated in These stands are used to mount louvre panels 460mm W. x 1220mm H. (1no.)
Louvres can be mounted on single side use.

Dimension : 475mm (W) X 630mm (D) X 1560mm (H)



RK BU STAND 1220-1560-01-S

RK BU BIN 005-----72no.-----Bin Size 168 (L) x 102 (W) x 74 (H)-----Single Side

RK BU STAND 1220-1560-02-S

RK BU BIN 615-----30no.-----Bin Size 201 (L) x 125 (W) x 101 (H)-----Single Side

RK BU STAND 1220-1560-03-S

RK BU BIN 725-----24no.-----Bin Size 229 (L) x 150 (W) x 126 (H)-----Single Side

RK BU STAND 1220-1560-04-S

RK BU BIN 835-----12no.-----Bin Size 300 (L) x 208 (W) x 158 (H)-----Single Side

RK BU STAND 1220-1560-05-S

RK BU BIN 945-----12no.-----Bin Size 348 (L) x 210 (W) x 200 (H)-----Single Side

RK BU STAND 1220-1560-06-S

RK BU BIN 005-----36no.-----Bin Size 168 (L) x 102 (W) x 74 (H)-----Single Side

RK BU BIN 615-----15no.-----Bin Size 201 (L) x 125 (W) x 101 (H)-----Single Side

RK BU STAND 1220-1560-07-S

RK BU BIN 725-----12no.-----Bin Size 229 (L) x 150 (W) x 126 (H)-----Single Side

RK BU BIN 835-----06no.-----Bin Size 300 (L) x 208 (W) x 158 (H)-----Single Side

Free standing stands are made from M.S. Steel Square Pipes of size 30mm (L) x 30mm (W) x 2.0mm (T) and are duly powder coated in These stands are used to mount louvre panels 460mm W. x 1220mm H. (1no.)
Louvres can be mounted on single side use.

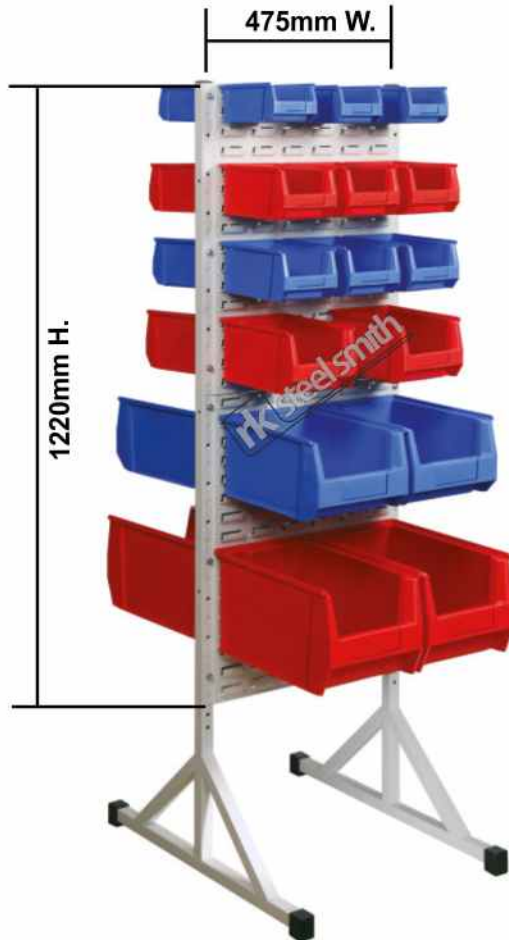

Dimension : 475mm (W) X 630mm (D) X 1560mm (H)

RK BU STAND 1220-1560-01-D

RK BU BIN 005-----72no.-----Bin Size 168 (L) x 102 (W) x 74 (H)-----Double Side

RK BU STAND 1220-1560-02-D

RK BU BIN 615-----30no.-----Bin Size 201 (L) x 125 (W) x 101 (H)-----Double Side

RK BU STAND 1220-1560-03-D

RK BU BIN 725-----24no.-----Bin Size 229 (L) x 150 (W) x 126 (H)-----Double Side

RK BU STAND 1220-1560-04-D

RK BU BIN 835-----12no.-----Bin Size 300 (L) x 208 (W) x 158 (H)-----Double Side

RK BU STAND 1220-1560-05-D

RK BU BIN 945-----12no.-----Bin Size 348 (L) x 210 (W) x 200 (H)-----Double Side

RK BU STAND 1220-1560-06-D

RK BU BIN 005-----36no.-----Bin Size 168 (L) x 102 (W) x 74 (H)-----Double Side

RK BU BIN 615-----15no.-----Bin Size 201 (L) x 125 (W) x 101 (H)-----Double Side

RK BU STAND 1220-1560-07-D

RK BU BIN 725-----12no.-----Bin Size 229 (L) x 150 (W) x 126 (H)-----Double Side

RK BU BIN 835-----06no.-----Bin Size 300 (L) x 208 (W) x 158 (H)-----Double Side

Standard Color option :



AMERICAN BLUE
STRUCTURE FINISH



7035 PALE GREY
STRUCTURE FINISH



DA GREY
STRUCTURE FINISH



PO RED
STRUCTURE FINISH



MACHINE GREEN
STRUCTURE FINISH

Assembled components are transfer to pre-treatment plant for treating in 7 tank for degrees, zinc, phosphating and passivation.

Material received from pre-treatment department are immediately powder coated in the dust free painting booth and then the articles are put inside a baking oven at a temperature of 180° C for about 20 minutes.

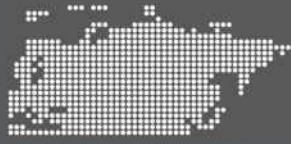

rk steel smith
defining workspace

 Plot- B/32 (Part-2) Bileshwar Indl. Estate,
Opp. G.V.M.M.,
Odhav-Kathwada Road,
Ahmedabad - 382415
Gujarat (INDIA).

 +91 95 120 00 550

 rksteelsmith@gmail.com
info@rksteelsmith.com
sales@rksteelsmith.com

 www.rksteelsmith.com