

rk steel smith
defining workspace

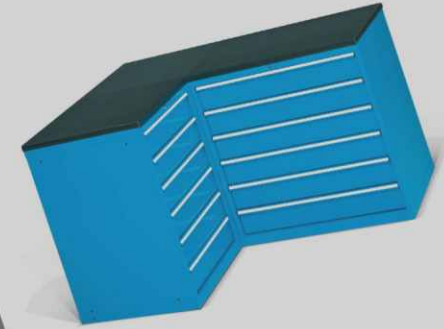

725MM WIDE CORNER SERIES TOOL CABINET

PRODUCT RANGE

2018

The factory is equipped with latest and modern machinery. For easy and fast movement of raw materials and finished goods suitable overhead crane railings and moving trolley systems are laid in the factory.

There are following main departments in production:

- Production Planning
- Press Shop
- Tool Room
- Assembly department for various products
- 7 Tank Pre-treatment Plant
- Powder coating & Liquid Painting Booth with baking oven
- Baking Oven
- Fitting
- Quality Inspection
- Packing
- Scheduling & despatching

Process of Manufacture :

100% Galvanised steel body are received in press shop where de-coiling and sheet leveling are done. After sheet leveling sheets are cut to require sizes. The cut size sheets are transferred to the power press and notching operation is carried out. After notching operation sheets are transferred to CNC press brakes for doing necessary bending.

Components which are received from press shop are transferred to assembly department for doing spot welding, Co2 welding, ARC welding, Grinding etc.

Assembled components are transfer to pre-treatment plant for treating in 7 tank for degrees, zinc, phosphating and passivation.

Material received from pre-treatment department are immediately powder coated in the dust free painting booth and then the articles are put inside a baking oven at a temperature of 180°C for about 20 minutes.

Then the painted items are sent to the fitting department for necessary fitment of necessary accessories and afterwards final inspection is carried out before packing the goods.

Material: (Housing)

- Housing 1.2mm thk.
- Vertical pillar 2mm thk.
- Horizontal support 2mm thk.
- Cross member 2mm thk.
- Forklift Base 2mm thk.

Material: (Drawer)

- Drawer 1.2mm thk.
- Drawer front face 2mm thk.
- Partition 1.2mm thk.
- Partition slotting strip 0.8mm thk. (Spot weld with Partition 1.2mm thk.)
- Divider 1.2mm thk.
- Drawer pull handle 1.2mm thk.

Material: (Slider)

- (1) Slider 3.0mm thk. with ZZ ball bearing (85 kg.)
725mm depth cabinet
- (2) Slider 4.0mm thk. with ZZ ball bearing (200 kg.)
725mm depth cabinet

The technical data contained in this catalogue is approximate. R.K. Steel Smith reserves the right to make any modifications it sees fit to improve the performance and appearance of products. The manufacturer is not liable for any printing errors.



1 Any free-standing drawer cabinet must be fastened to the floor.



2 Cabinets in a row should be bolted together through the sidewalls. The end walls should be fastened to the floor (see #3 side). For the side-to-side bolt kit.

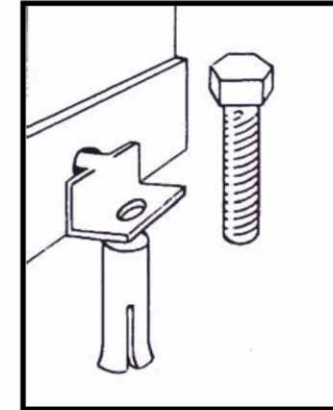

3 fork truck base or frame base, insert angle piece into hole in bottom. For the floor bolt kit.

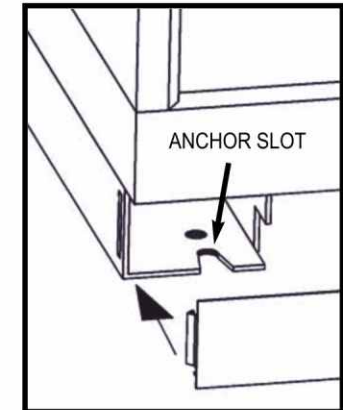

4 Alternate anchoring for cabinets with fork truck base: properly anchor base to floor at front and back using the slots indicated.

- Properly position rear anchors and bolts (customer-supplied), allowing enough clearance to slide the cabinet into position.

- Install front anchors.

CAUTION

ALWAYS BOLT CABINETS SIDE-TO-SIDE OR ANCHOR TO THE FLOOR BEFORE LOADING TO PREVENT CABINET TIPPING.

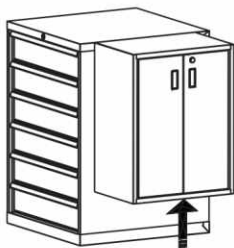

ALWAYS SUPPORT SIDE-MOUNTED CABINETS BEFORE REMOVING DRAWERS TO PREVENT CABINET TIPPING.

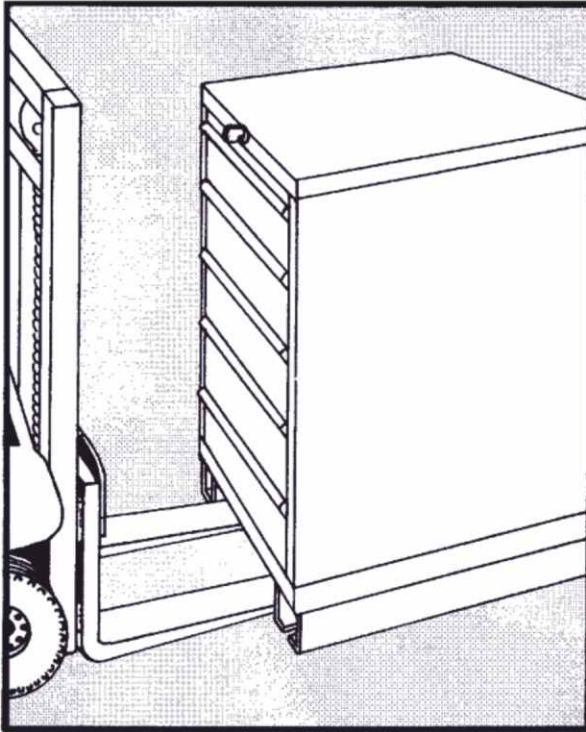

All drawer cabinets should be locked while moving.

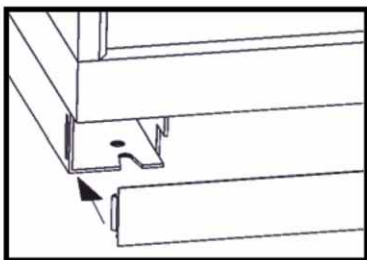

Base cover plate easily snaps on and off to allow for pick-up by fork or pallet truck.

⚠ CAUTION



Do not step into an open drawer.



Do not sit on an open drawer.



Open only one drawer at a time.



The load capacity per drawer (as shown in the catalog) is designed for evenly distributed loads.



Do not drop any heavy loads into a drawer.



All cabinets should be secured to prevent tipping.

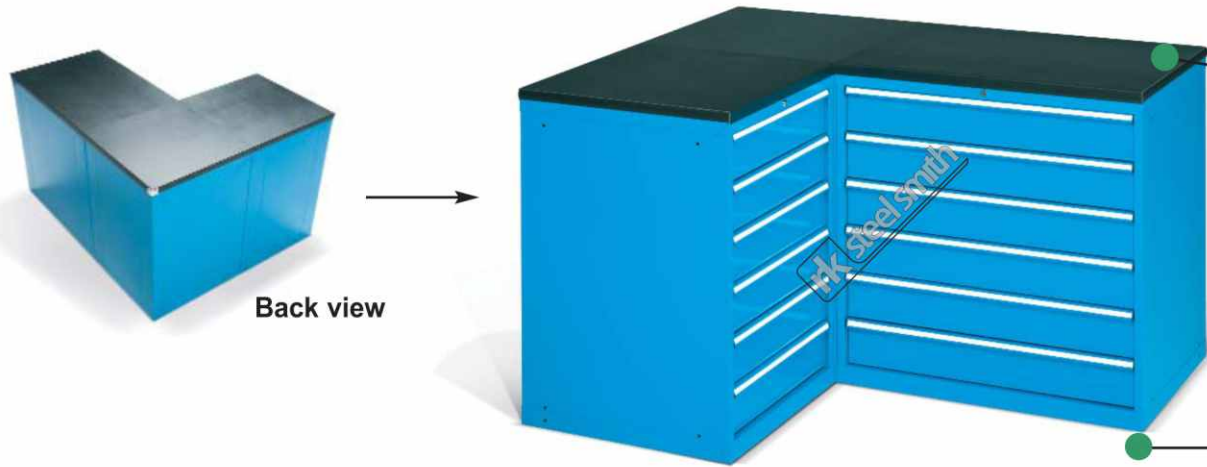

Back view



Angle section edging (4 side)

35mm Thk. (Standard) Ply top and 4mm Thk. Rubber sheet with Angle section edging (4 side) covered with a 1.5 mm thk.

Forklift Base 100mm H. (Easy Relocation)

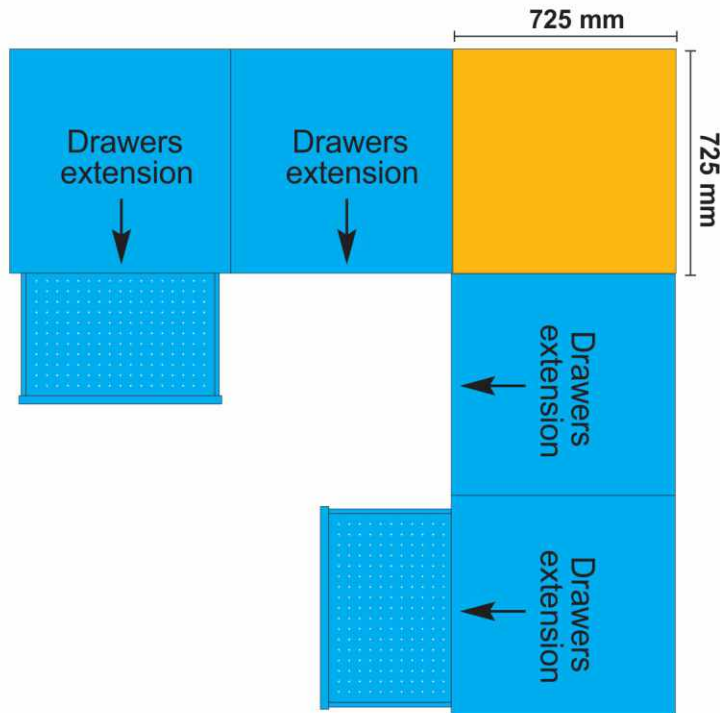

RK COR TC 725 01

Technical Detail:

- (1) Each Cabinet size:
725mm W. X 725mm D. X 950mm H.
- (2) Each drawer load cap.: **85kg.**
- (3) Drawer Normal Extension: **80%**
- (4) Usable drawer dimensions :
600mm W. x 600mm D.
- (5) Manufacturing & Materials Details:
Page-02
- (6) Select cabinet combination model no.:
Page-05
- (7) Standard: **Plain Drawer**
Option: Drawers interior-Page-06

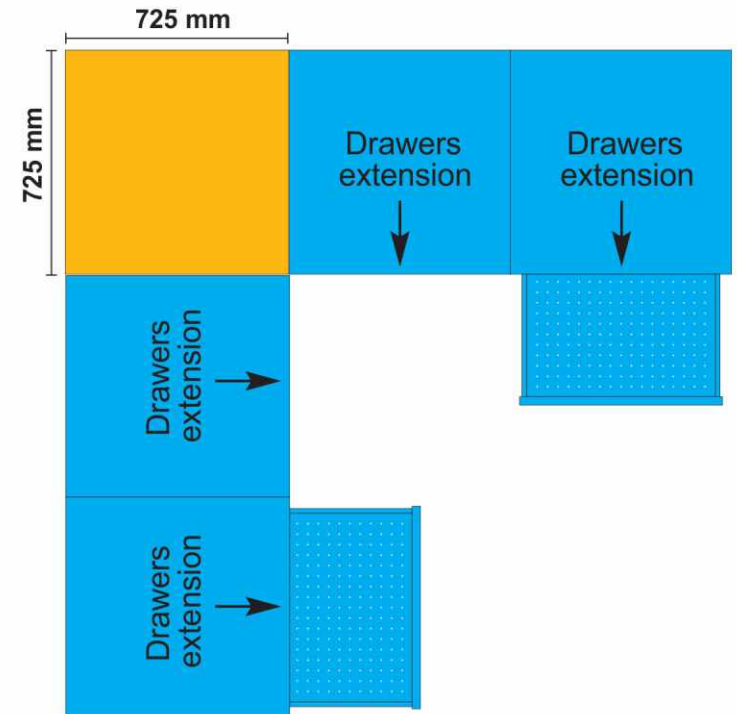

RK COR TC 725 02

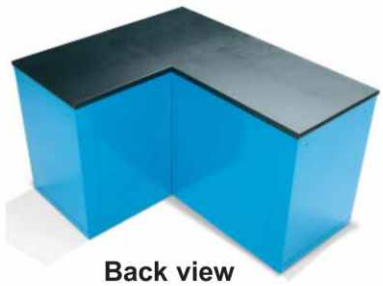

35mm Thk. (Standard) Ply top and 4mm Thk. Rubber sheet with Angle section edging (4 side) covered with a 1.5 mm thk.

Forklift Base 100mm H. (Easy Relocation)

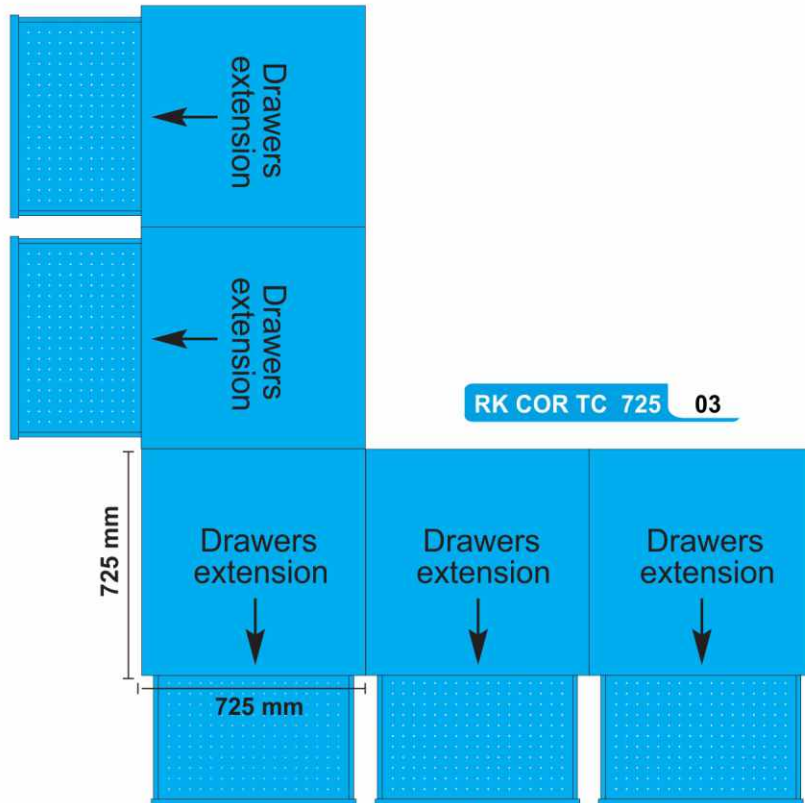

Technical Detail:

- (1) Each Cabinet size:
725mm W. X 725mm D. X 950mm H.
- (2) Each drawer load cap.: **85kg.**
- (3) Drawer Normal Extension: **80%**
- (4) Usable drawer dimensions :
600mm W. x 600mm D.
- (5) Manufacturing & Materials Details:
Page-02
- (6) Select cabinet combination model no.:
Page-05
- (7) Standard: **Plain Drawer**
Option: Drawers interior-Page-06

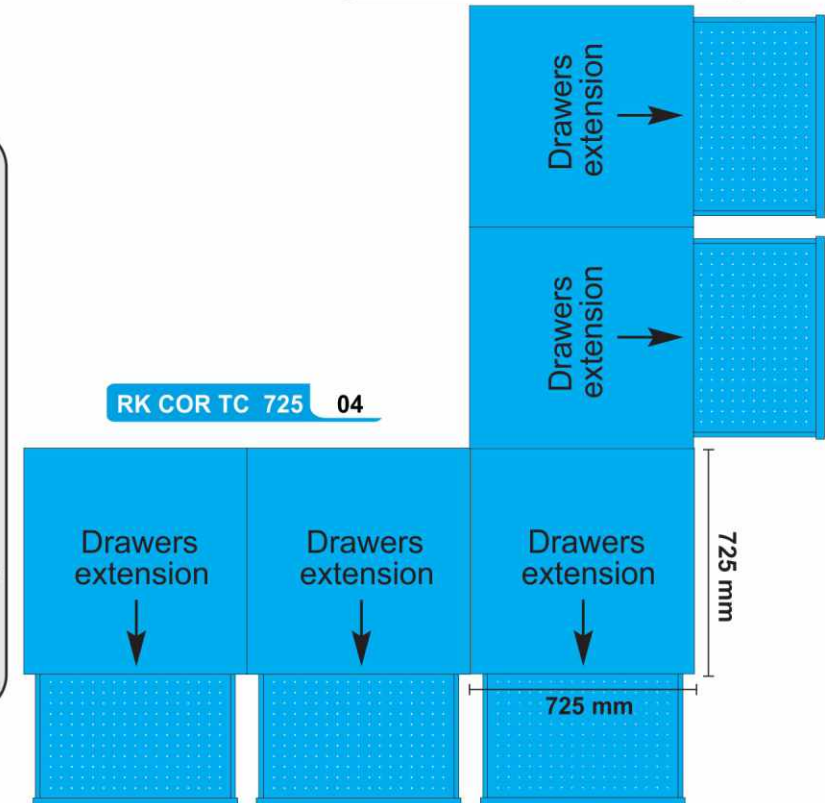

Technical Detail:

- (1) Each Cabinet size: **725mm W. X 725mm D. X 900mm H.**
- (2) Each drawer load cap.: **85kg.**
- (3) Drawer Normal Extension: **80%**
- (4) Usable drawer dimensions : **600mm W. x 600mm D.**
- (5) Manufacturing & Materials Details: **Page-02**
- (6) Select cabinet combination model no.: **Page-07**
- (7) Standard: **Plain Drawer** **Option: Drawers interior-Page-08**



Model no.:	Cabinet Size:			Drawer configuration:
	wide	depth	height	
RK TC 725 725D-01	725	725	800	100X4, 150X2 Drawers
RK TC 725 725D-02	725	725	800	75X2, 100X4, 150X1 Drawers
RK TC 725 725D-03	725	725	800	100X7 Drawers
RK TC 725 725D-04	725	725	800	100X2, 200X1, 300X1 Drawers
RK TC 725 725D-05	725	725	800	75X2, 100X2, 150X1, 200X1 Drawers

Drawers Layout for 75 to 150mm H. Drawers (150mm onward plain drawers)

RK TC DR 725 001

600W X 600D

75mm to 300mm
drawers



RK TC DR 725 002

600W X 600D

75mm to 300mm
drawers



RK TC DR 725 003

300W X 300D-4no.
Each compartment

75/100/150 drawers

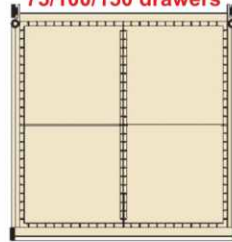

RK TC DR 725 004

300W X 200D-6no.
Each compartment

75/100/150 drawers

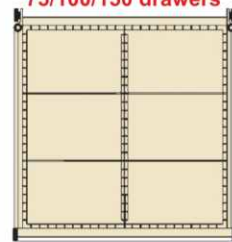

RK TC DR 725 005

300W X 150D-8no.
Each compartment

75/100/150 drawers

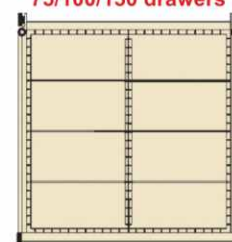

RK TC DR 725 006

200W X 300D-6no.
Each compartment

75/100/150 drawers

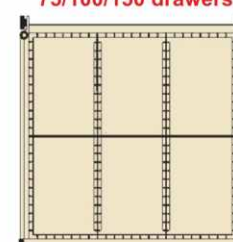

RK TC DR 725 007

200W X 200D-9no.
Each compartment

75/100/150 drawers

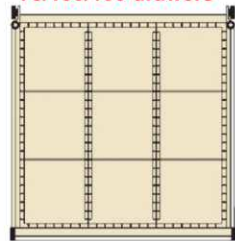

RK TC DR 725 008

200W X 150D-12no.
Each compartment

75/100/150 drawers

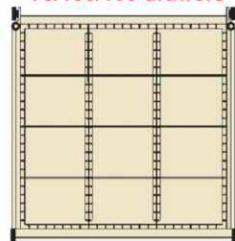

RK TC DR 725 009

150W X 300D-8no.
Each compartment

75/100/150 drawers

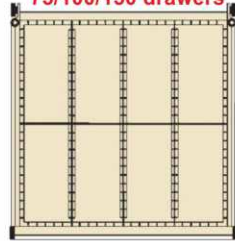

RK TC DR 725 010

150W X 200D-12no.
Each compartment

75/100/150 drawers



RK TC DR 725 011

150W X 150D-16no.
Each compartment

75/100/150 drawers

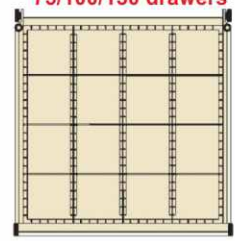

Plastic container only for 75 & 100mm H. Drawers



45mm H.
75mm Drawers



75mm H.
100mm Drawers

RK TC DR 725 P01

75/100 drawers

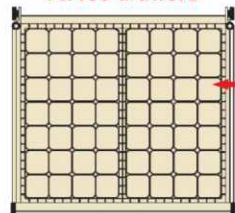

75W.X75D.X45/75H.
56no.
Plastic container
in each drawer

RK TC DR 725 P02

75/100 drawers

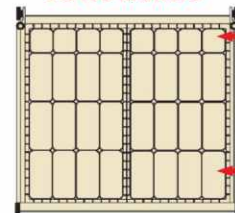

75W.X75D.X45/75H.
08no.
Plastic container
in each drawer

75W.X150D.X45/75H.
24no.
Plastic container
in each drawer

RK TC DR 725 P03

75/100 drawers

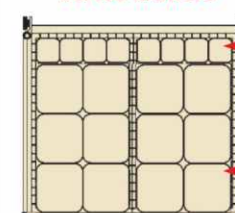

75W.X75D.X45/75H.
08no.
Plastic container
in each drawer

150W.X150D.X45/75H.
12no.
Plastic container
in each drawer

Standard Color option :



AMERICAN BLUE
STRUCTURE FINISH



7035 PALE GREY
STRUCTURE FINISH



DA GREY
STRUCTURE FINISH



PO RED
STRUCTURE FINISH

Assembled components are transfer to pre-treatment plant for treating in 7 tank for degrees, zinc, phosphating and passivation.

Material received from pre-treatment department are immediately powder coated in the dust free painting booth and then the articles are put inside a baking oven at a temperature of 180° C for about 20 minutes.



rk steel smith
defining workspace



Plot- B/32 (Part-2) Bileshwar Indl. Estate,
Opp. G.V.M.M.,
Odhav-Kathwada Road,
Ahmedabad - 382415
Gujarat (INDIA).



+91 94 281 35 100
+91 98 253 00 059



rksteelsmith@gmail.com
info@rksteelsmith.com
sales@rksteelsmith.com



www.rksteelsmith.com