



rk steel smith
defining workspace

1500MM WIDE
PACKAGING WORKBENCH
PRODUCT RANGE



2018



Mobile Cartoon Stand

03



Workbench
Wooden Top

11



Workbench

04 to 10



Colour

12



1500W. X 600D. X1600H.
40 X 40 X 2mm thk. pipe construction
PU wheel: 125mm dia. X 32 thk.
(2-fix, 2-brake)
Static Load Cap. 350kg.
4no. divider

RK WS PACK 001



1500W. X 600D. X1600H.
Adjustable level
40 X 40 X 2mm thk. pipe construction
PU wheel: 125mm dia. X 32 thk.
(2-fix, 2-brake)
Static Load Cap. 350kg.
8no. divider

RK WS PACK 002



1500W. X 600D. X1600H.
Adjustable level
40 X 40 X 2mm thk. pipe construction
PU wheel: 125mm dia. X 32 thk.
(2-fix, 2-brake)
Static Load Cap. 350kg.
8no. divider

RK WS PACK 003



1500W. X 600D. X1800H.
Adjustable level
40 X 40 X 2mm thk. pipe construction
PU wheel: 125mm dia. X 32 thk.
(2-fix, 2-brake)
Static Load Cap. 350kg.
12no. divider

RK WS PACK 004



1200W. X 600D. X1200H.
40 X 40 X 2mm thk. pipe construction
Adjustable level
Static Load Cap. 350kg.

RK WS PACK 005

1500W. X 600D. X1200H.
40 X 40 X 2mm thk. pipe construction
Adjustable level
Static Load Cap. 350kg.

RK WS PACK 006



1200W. X 600D. X1600H.
40 X 40 X 2mm thk. pipe construction
Adjustable level
Static Load Cap. 350kg.

RK WS PACK 007

1500W. X 600D. X1600H.
40 X 40 X 2mm thk. pipe construction
Adjustable level
Static Load Cap. 350kg.

RK WS PACK 008

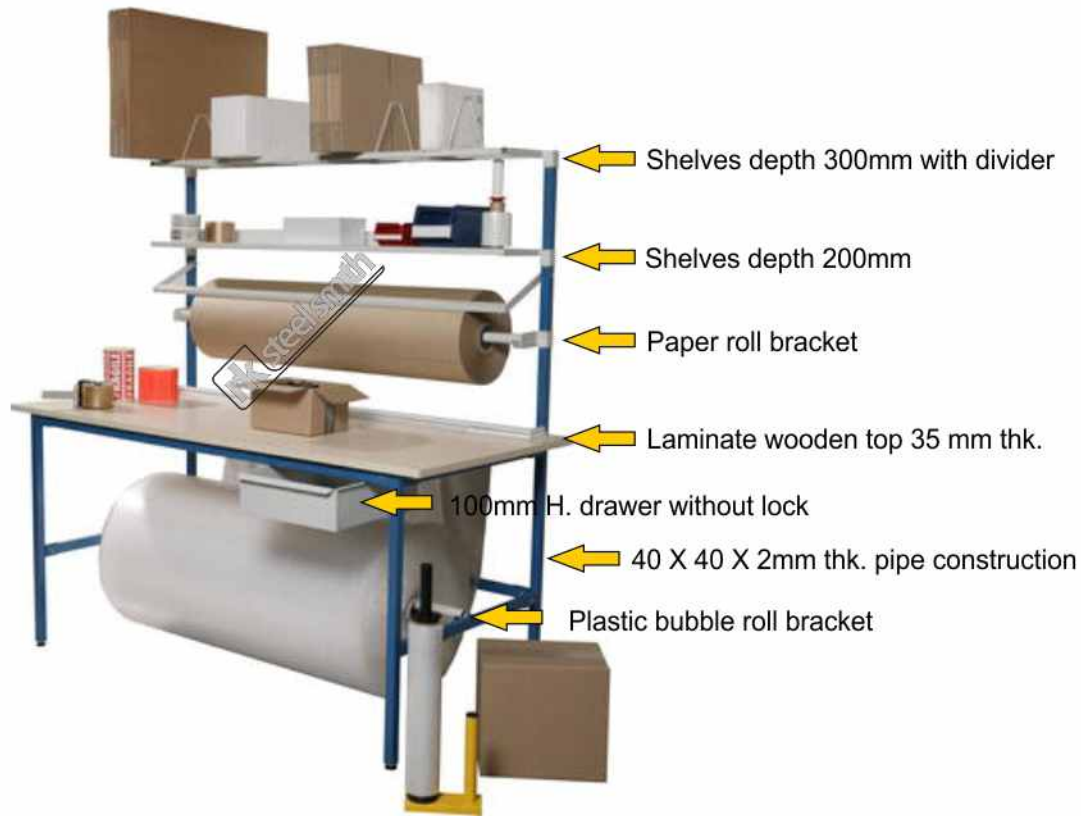

RK WS PACK 009

1500W. X 800D. X 1850H. mm

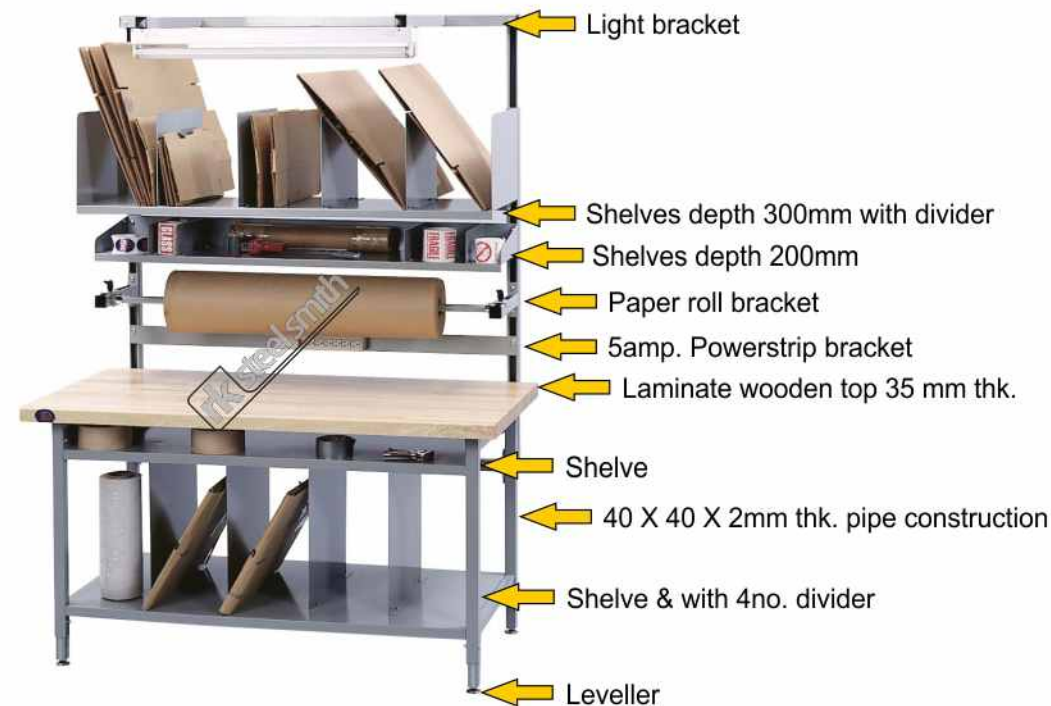

RK WS PACK 010

1500W. X 800D. X 1850H. mm

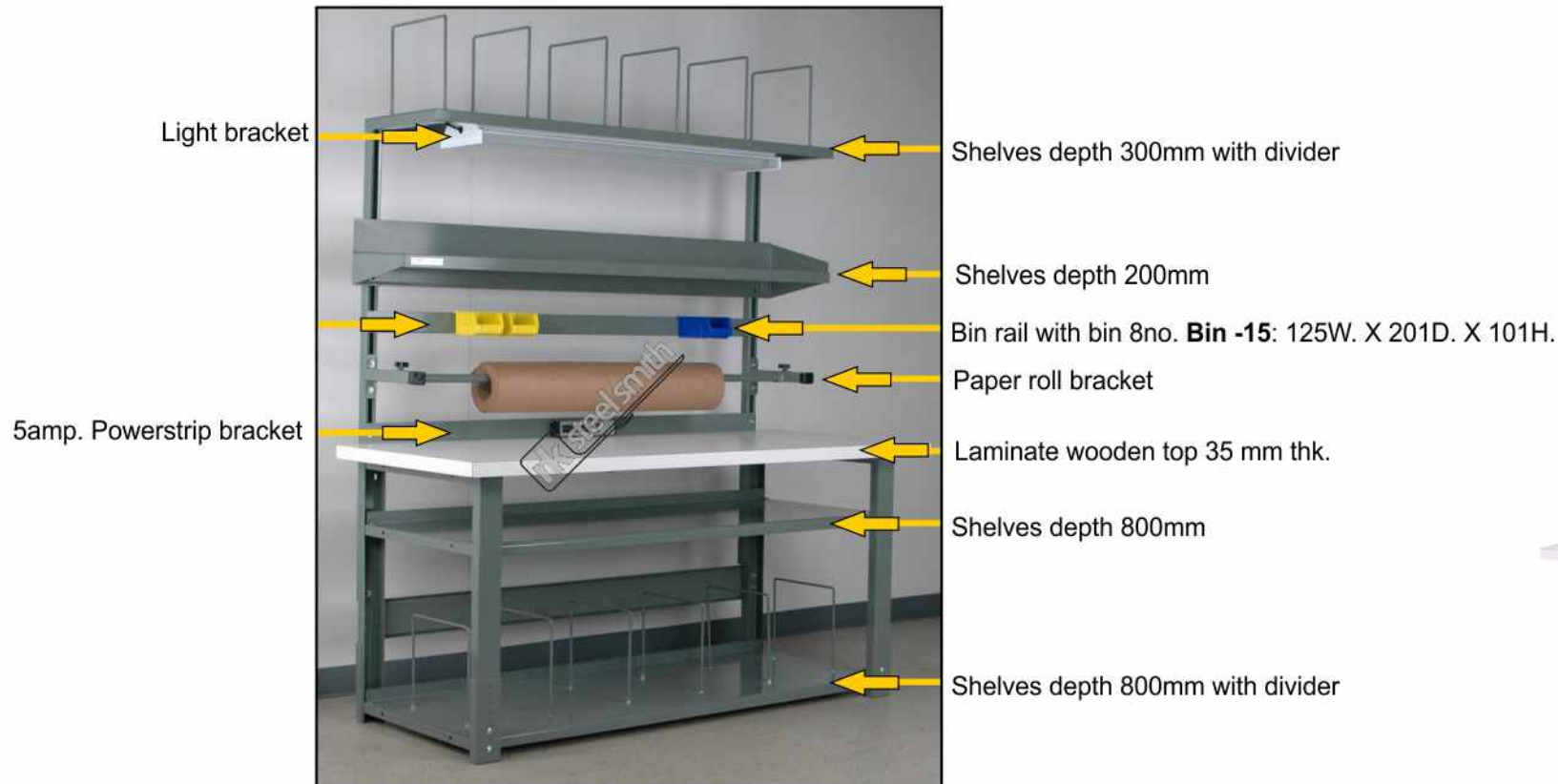

RK WS PACK 011

1500W. X 800D. X 1850H. mm



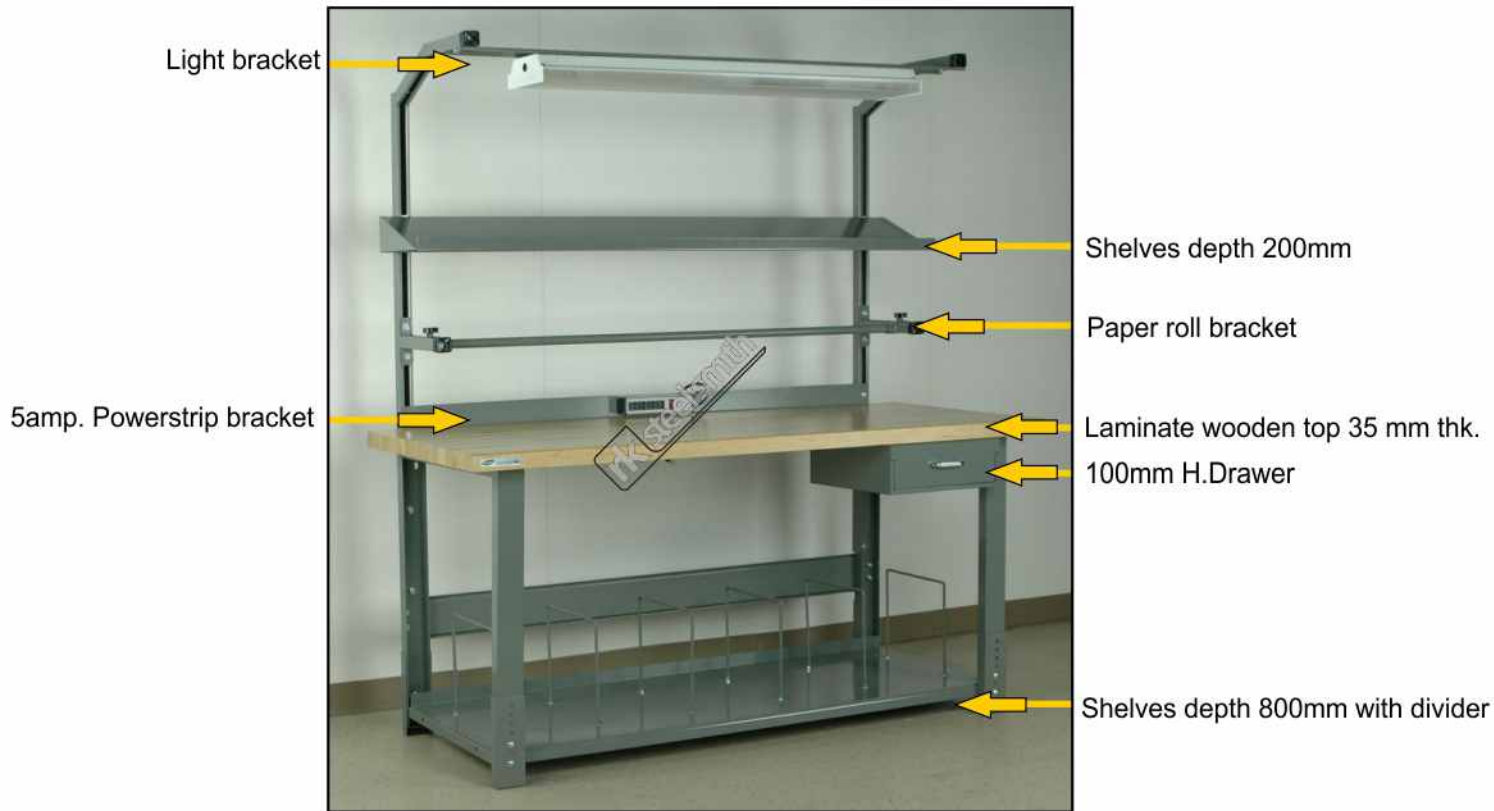

RK WS PACK 012

1500W. X 800D. X 1850H. mm



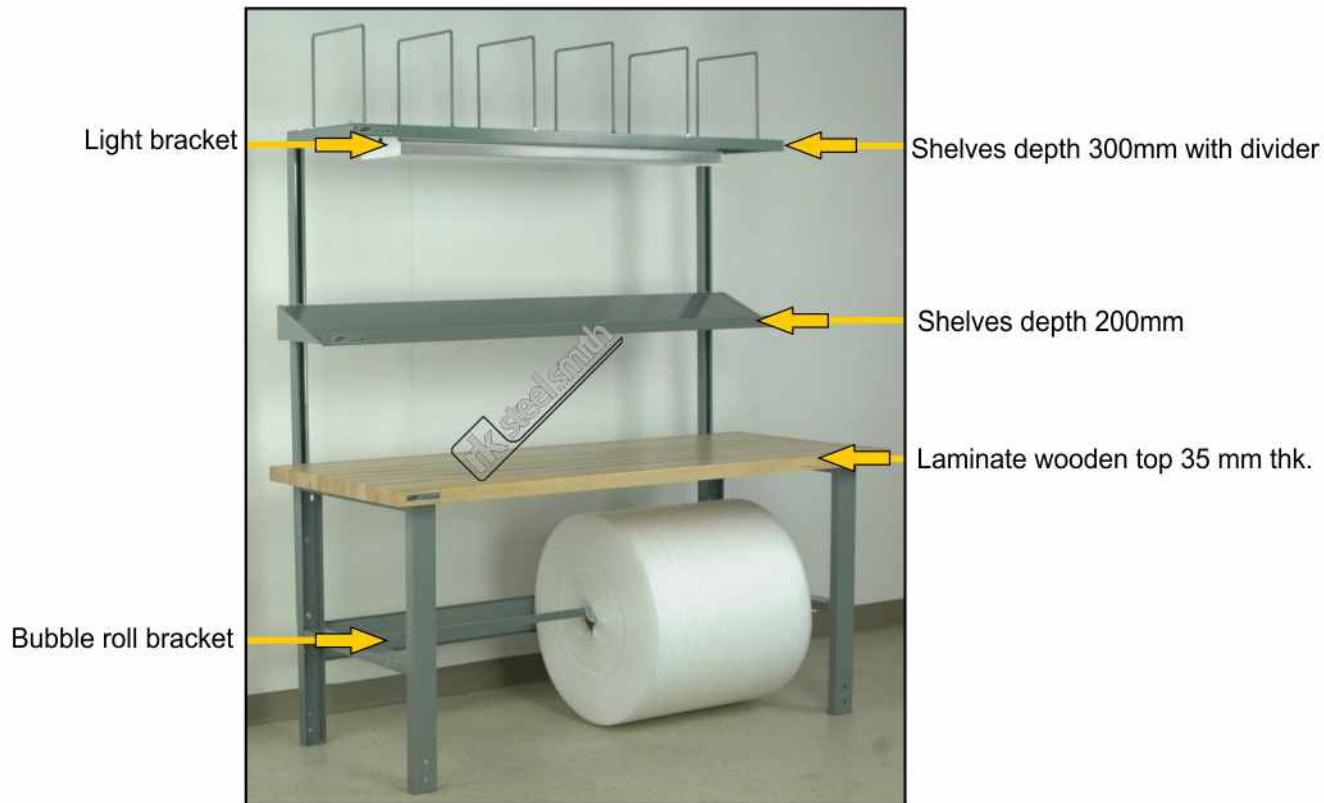

RK WS PACK 013

1500W. X 800D. X 1850H. mm

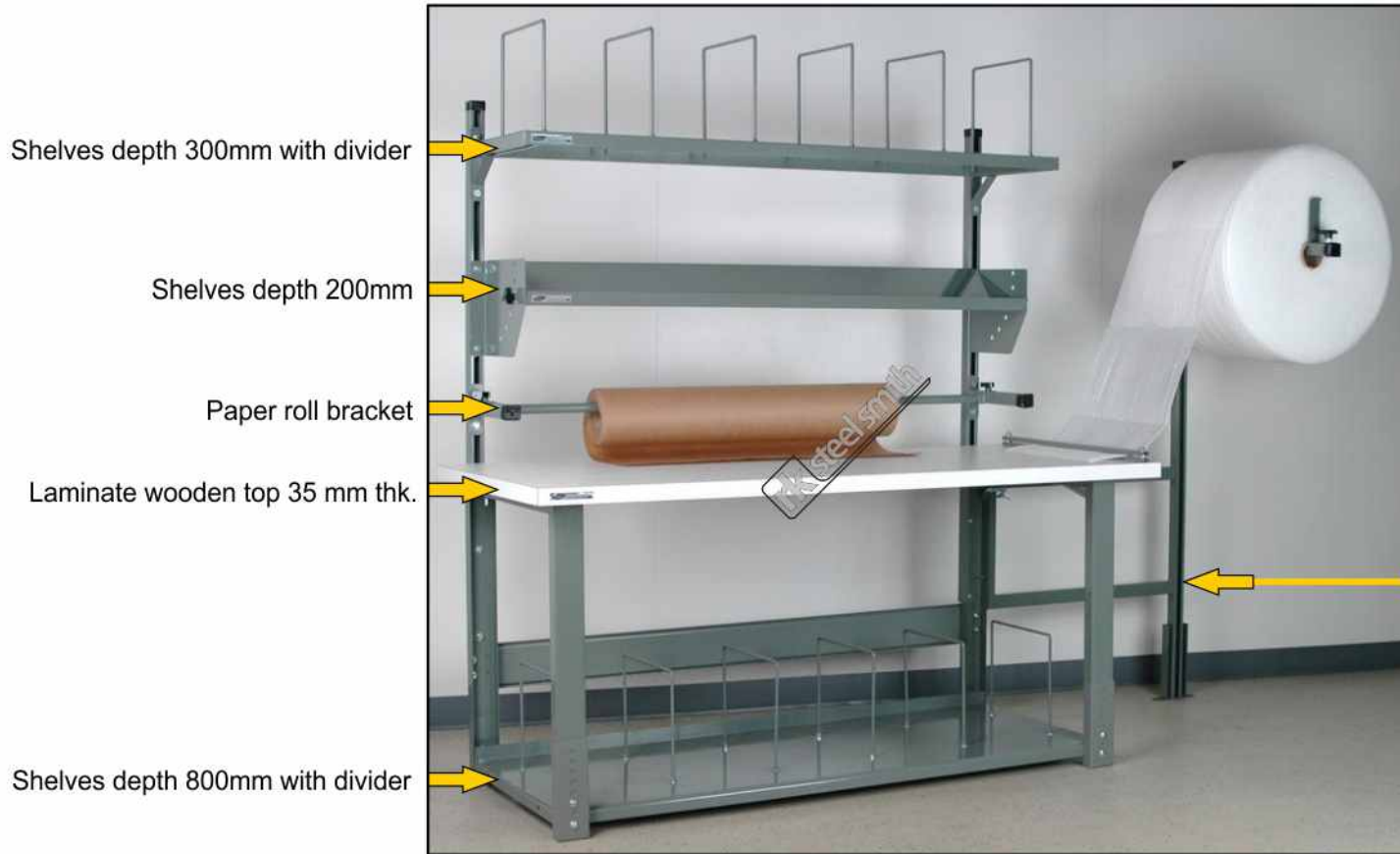

RK WS PACK 014

1500W. X 800D. X 1850H. mm

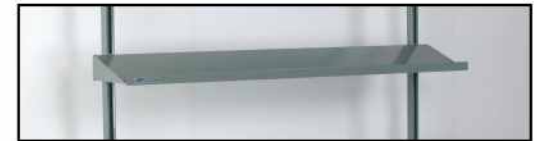
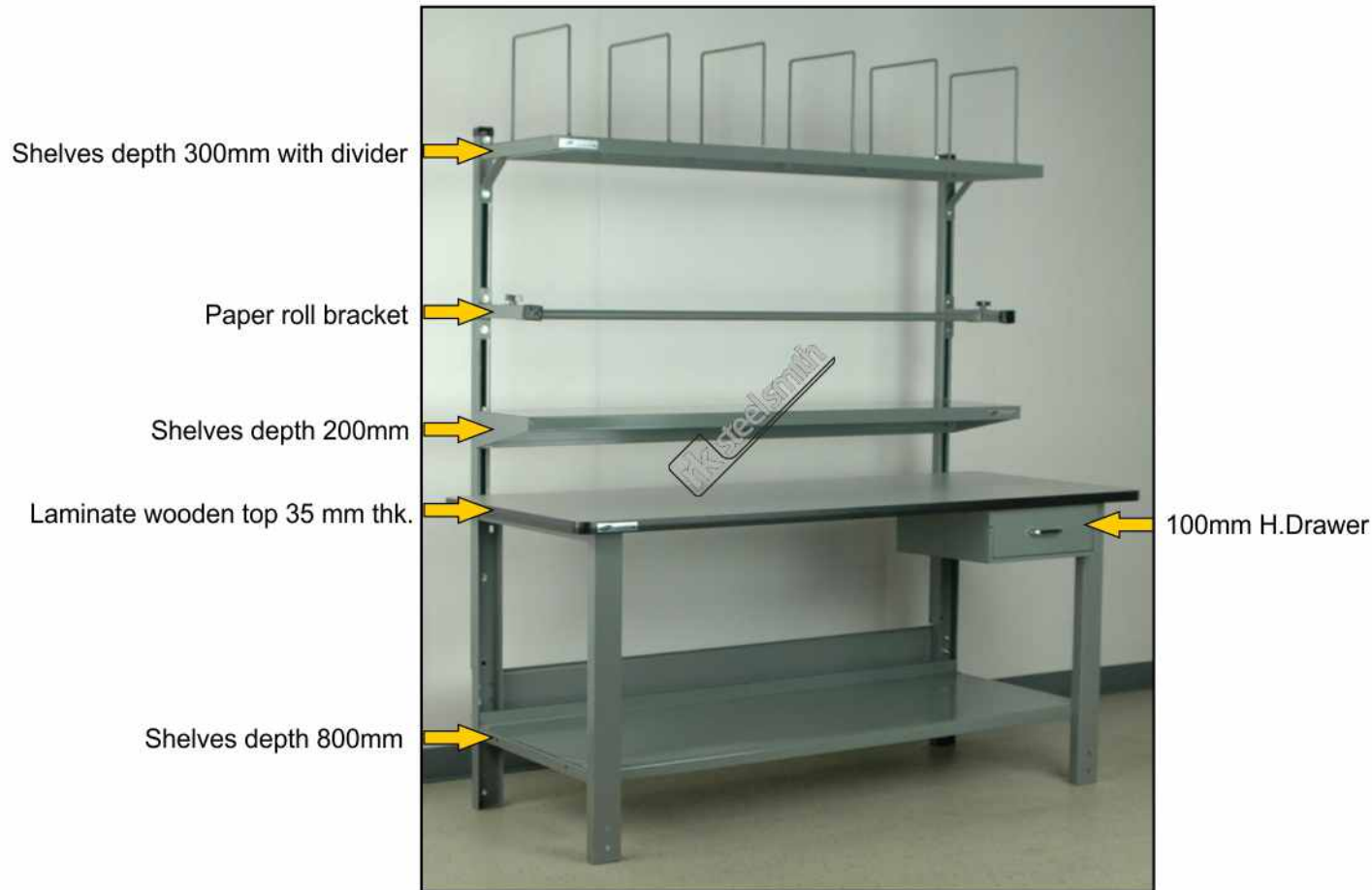

RK WS PACK 015

1500W. X 800D. X 1850H. mm

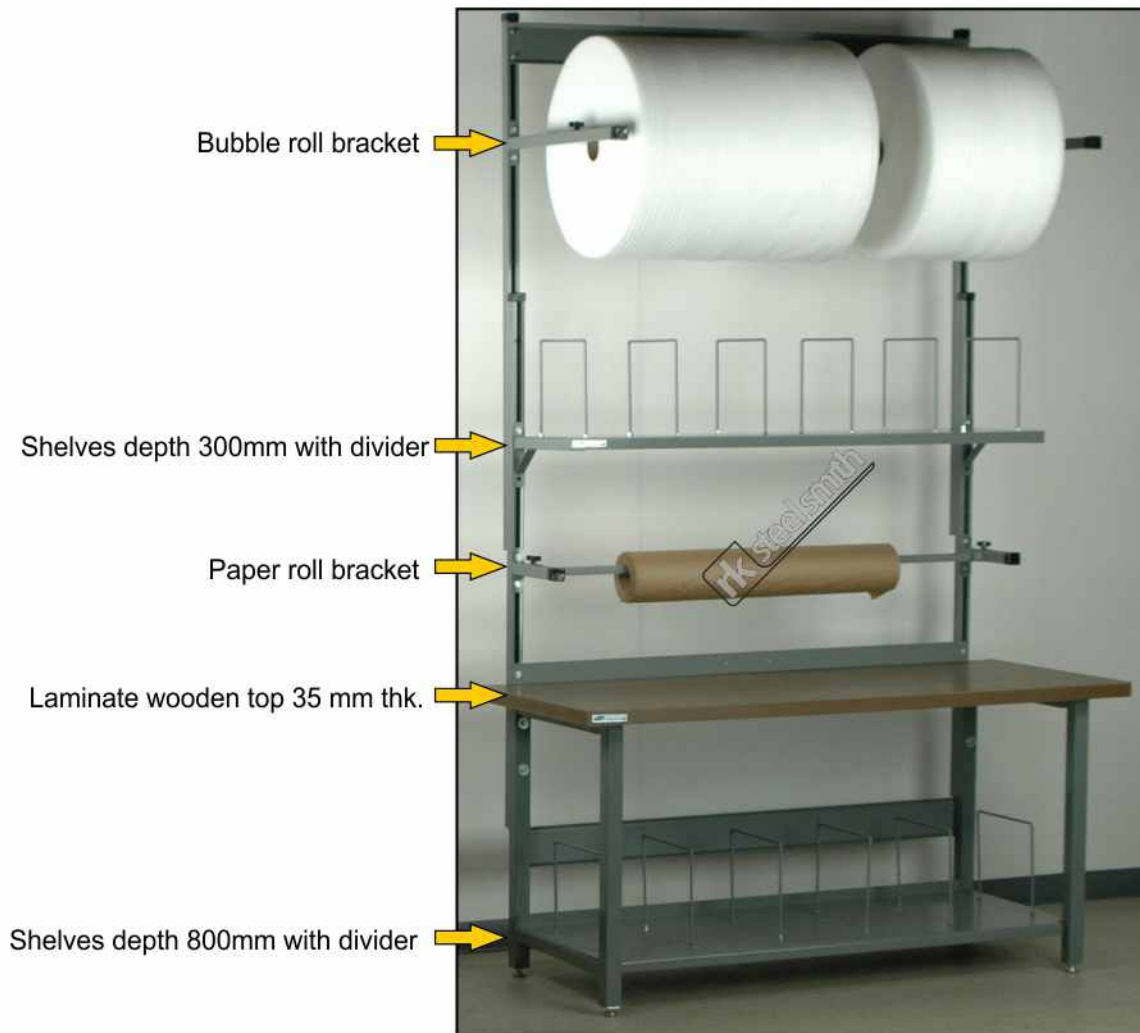

RK WS PACK 016

1500W. X 800D. X 2000H. mm

RK WS TOP 001



35mm Thk. (Standard)
50mm Thk. (Option) Ply top
and 4mm Thk. Loose rubber sheet
Border cover with solid wood
with natural polish.

RK WS TOP 002

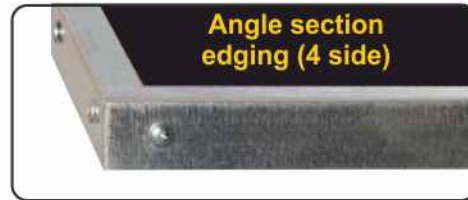

35mm Thk. (Standard)
50mm Thk. (Option) Ply top and
4mm Thk. Rubber sheet with
Angle section edging (4 side)
covered with a 1.5 mm thk.

RK WS TOP 003

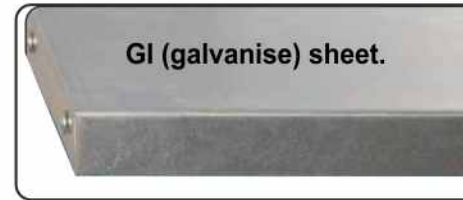

35mm Thk. (Standard)
50mm Thk. (Option) Ply top
covered with a 1.5 or 2.0 mm thk.
GI (galvanise) sheet.

RK WS TOP 004

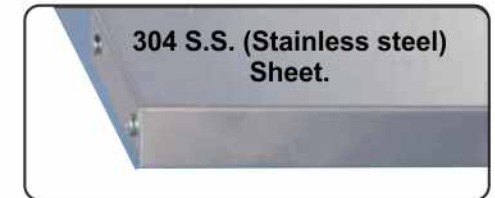

35mm Thk. (Standard)
50mm Thk. (Option) Ply top
covered with a 1.5 or 2.0 mm thk.
304 S.S. (Stainless steel) Sheet.

RK WS TOP 005

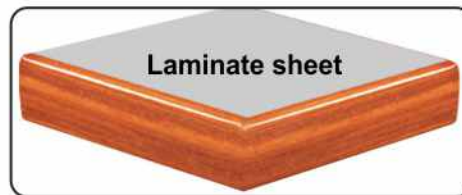

35mm Thk. (Standard)
50mm Thk. (Option) Ply top
1mm Laminate Sheet,
Border cover with solid wood
with natural polish.

RK WS TOP 006

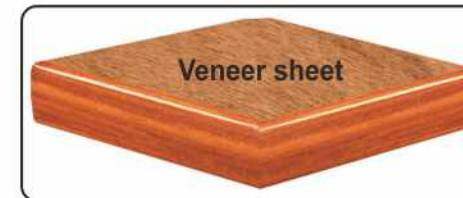

35mm Thk. (Standard)
50mm Thk. (Option) Ply top
4mm Veneer Sheet,
Border cover with solid wood
with natural polish.

Standard Color option :



AMERICAN BLUE
STRUCTURE FINISH



7035 PALE GREY
STRUCTURE FINISH



DA GREY
STRUCTURE FINISH



PO RED
STRUCTURE FINISH

Assembled components are transfer to pre-treatment plant for treating in 7 tank for degrees, zinc, phosphating and passivation.

Material received from pre-treatment department are immediately powder coated in the dust free painting booth and then the articles are put inside a baking oven at a temperature of 180° C for about 20 minutes.



rk steel smith
defining workspace



Plot- B/32 (Part-2) Bileshwar Indl. Estate,
Opp. G.V.M.M.,
Odhav-Kathwada Road,
Ahmedabad - 382415
Gujarat (INDIA).



+91 94 281 35 100
+91 98 253 00 059



rksteelsmith@gmail.com
info@rksteelsmith.com
sales@rksteelsmith.com



www.rksteelsmith.com